

onn.TM

onn.TM • Roku TV

QUICK START GUIDE

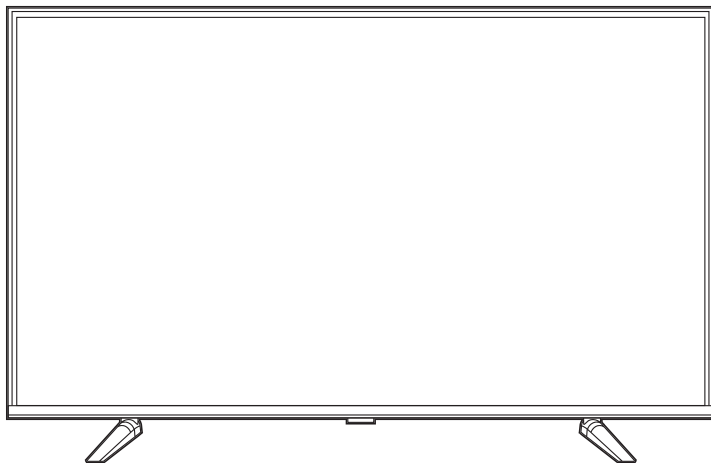

Overview

What's included:

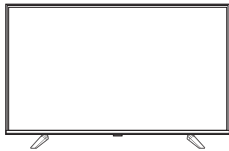

onn. • Roku TV



TV Remote

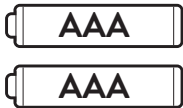

2 x AAA Batteries
for Remote

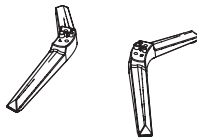

TV Stand



Screws

Tools required:



Phillips
Head
Screwdriver



Wireless
Router
(needed for
streaming)



Computer,
Tablet, or
Smartphone
(needed for setup)



Internet
Connection
(needed for
streaming)

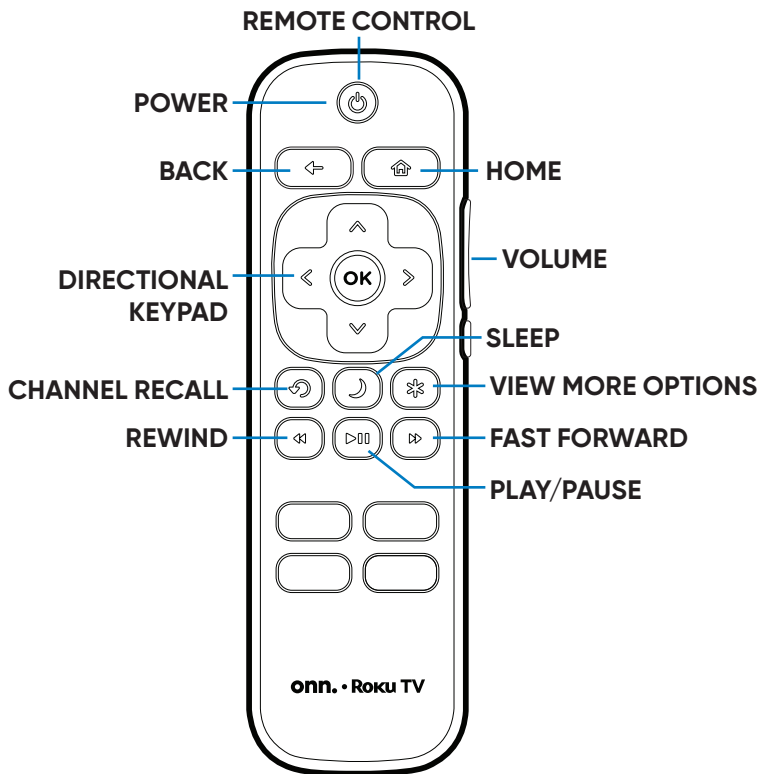

Power your TV remote by inserting the included batteries carefully matching (+) and (-) indicated inside the battery compartment.

For product assistance & missing or replacement parts:

WE CAN HELP

1-844-334-2355

7 DAYS/WEEK 9:00am - 9:00pm EST

ONLINE CHAT:

onntvsupport.com

EMAIL:

customerservice@onntvsupport.com



SCAN HERE

Register your product to activate
your two-year warranty.*

*1-year manufacturer's limited warranty with purchase, or 2-year limited warranty with product registration within 90 days of purchase. See warranty card for details.

Find more at **Walmart.com**

We recommend keeping your TV box for the duration of your warranty. See your product warranty for details.

Assembly

1. INSTALLING THE STANDS

Using a **Phillips screwdriver**

Do not install the stands if you want to wall mount your TV. See your wall mount instructions for mount installation details.

1. Place the TV screen-down on a clean, flat, soft surface (e.g.: blanket) to prevent scratches or damage to the screen.
2. Use a Phillips screwdriver to attach each stand with the provided screws.
3. Place the TV upright on a stable, level surface.

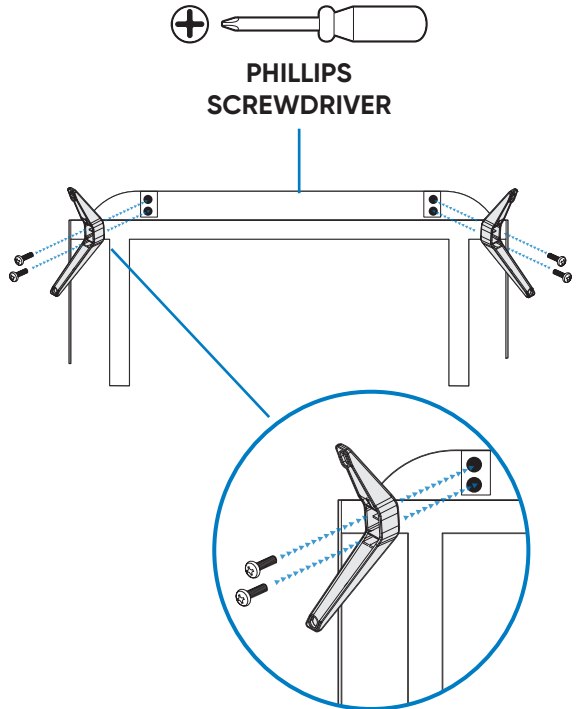

2. CONNECTING DEVICES

HDMI

connect a Blu-ray, DVD player, gaming console or other devices

Best Quality

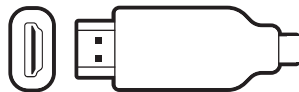

DIGITAL OPTICAL

connect an external digital audio system

Better Quality

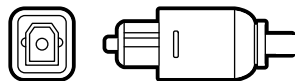

COMPONENT

connect an external AV device

Good Quality

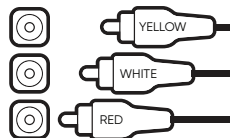

COAXIAL

connect to antenna/cable



2. CONNECTING DEVICES (continued)

LAN

wired connection
to the internet (4K models only)

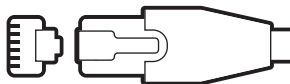

HEADPHONE

connect headphones
or external speakers



USB

connect for photos, music,
movies and more



CONNECTING TO POWER

After connecting all your devices, connect the power cord to a power outlet. The TV enters standby mode and its indicator light turns red.

Setup

ACTIVATION:

Have your wireless network name and password handy.

Follow the on-screen instructions on your onn™ Roku TV. If you aren't ready to connect your TV to a wireless network, you can still use it as a regular TV.

Activate your onn™ Roku TV using your computer, smartphone, or tablet to link to a Roku account. You need a Roku account to activate your onn™ Roku TV and access entertainment across thousands of streaming channels.

NOTE:

Roku doesn't charge for activation support - **beware of scams.**

Visit go.roku.com/tvmanual
for the complete Roku User Guide.